



The "IMPACT" series of Gefran, are pressure transmitters, without transmission fluid, for using in High temperature environment (350°C).

Medium pressure is transferred directly to the sensitive silicon element via a thick diaphragm.

Strain is transduced by a micro-worked silicon structure (MEMS). The sensors are based on a piezoresistive technology, have been checked following the NAMUR NE21 and NE43 recommendations and are in compliance with:

- EMC 2004/108/CE standard
- European RoHS 2002/95/CE standard

"IMPACT" is Gefran's exclusive series of high-temperature pressure sensors that use the piezoresistive principle.

The main characteristic of "IMPACT" sensors is that they do not contain any transmission fluid.

The sensitive element, directly positioned behind the contact membrane, is realised in silicon through microprocessing techniques.

The micro structure includes the measurement membrane and piezoresistors.

The minimum deflection required by the sensitive element makes it possible to use very robust mechanics.

The process contact membrane can be up to 15 times thicker than the membrane used in traditional Melt sensors.

### ADVANTAGES

- Total compatibility with the European RoHS Directive
- High strength
- Long life
- Working temperature: up to 350°C
- Excellent read stability over time
- Fast response time

### MAIN FEATURES

- Pressure ranges: 0-100 to 0-1000 bar / 0-1500 to 0-15000 psi
- Accuracy: < ±0.25% FSO (H); < ±0.5% FSO (M)
- Standard threading 1/2-20UNF, M18x1.5; other versions on request
- Other types of diaphragms are available on request
- Autozero function on board / external option
- 15-5 PH stainless steel diaphragm GTP coated

### AUTOZERO FUNCTION

All signal variations in the absence of pressure can be eliminated by using the Autozero function.

This function is activated by closing a magnetic contact located in the electronic transmitter or by an external contact.

The procedure is allowed only at zero" pressure.

The Autozero function should be activated ONLY when the sensor is completely installed on the system.

Power with galvanic insulated barrier with 30V maximum voltage.

For version IX2, the thermocouple must be connected to EX-i circuits with devices assigned to galvanic separation and with protection mode [EX ia] IIC.



EC-Type Examination Certificate number:  
**IMQ 09 ATEX 002**

### TECHNICAL SPECIFICATIONS

Accuracy (1)	<b>H</b> <±0.25%FSO <b>M</b> <±0.5%FSO
Resolution	16 Bit
Measurement range	0..100 to 0..1000bar 0..1500 to 0..15000psi
Maximum overpressure (without degrading performances)	1.5 x FS (maximum pressure 1200bar/17400psi)
Measurement principle	Piezoresistive
Power supply	10...30Vdc
Maximum current absorption	23mA
Insulation resistance (50Vdc)	>1000 MOhm
Output signal Full Scale FSO	20mA
Zero balance (tolerance ± 0.25% FSO)	4mA
Zero signals adjustment (tolerance ± 0.25% FSO)	"Autozero" function
Maximum allowed load	See diagram
Response time (10...90% FSO)	8ms
Output noise (RMS 10-400Hz)	< 0.025% FSO
Calibration signal	80% FSO
Output short circuit ingress and reverse polarity protection	YES
Compensated temperature range housing	0...+85°C
Operating temperature range housing	-20...+85°C
Storage temperature range housin	-40...+125°C
Maximum diaphragm temperature	350°C / 660°F
Zero signal variation due to process temperature variation in range (20-350°C)	< ± 1,2%FSO
Span signal variation due to process temperature variation in range (20-350°C)	< ± 1%FSO
Std contact diaphragm with process	15-5 PH GTP
Thermocouple (model IX2)	STD: type "J" (isolated junction) type "K" (on request)
Protection degree (with 6-pole female connector)	IP65
Electrical connection	Conn. 6-pin VPT07RA10-6PT (PT02A-10-6P) Conn. 8-pin PC02E-12-8P Cable output

FSO = Full scale output (1) BFSL method (Best Fit Straight Line); includes combined effects of Non-Linearity, Hysteresis and Repeatability.

# MECHANICAL DIMENSIONS

**IX0**

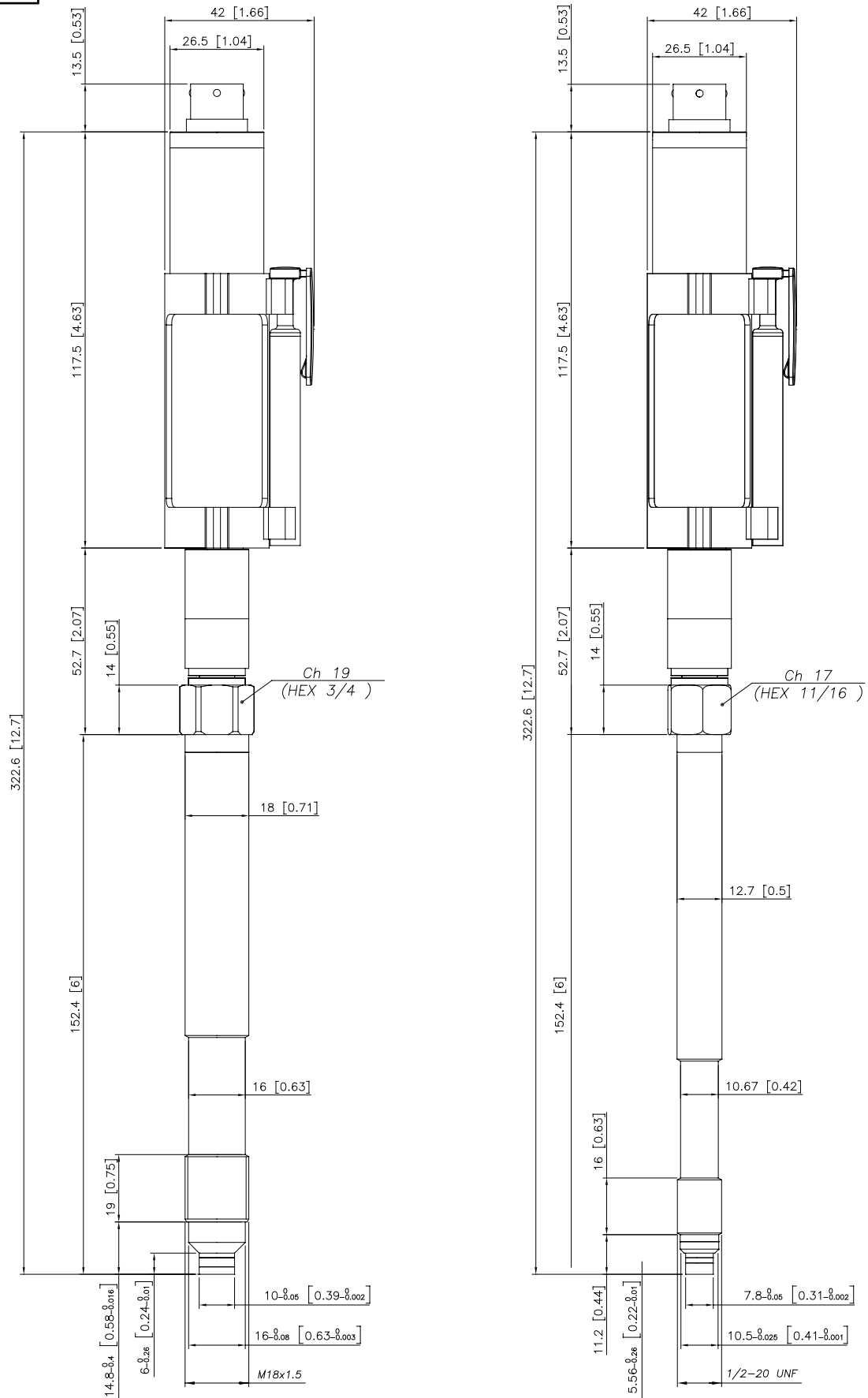

**NOTE :** dimensions refer to rigid stem length option "4" (153 mm – 6")

**WARNING :** For installation use a maximum tightening torque of 40 Nm (355 in-lb)

# MECHANICAL DIMENSIONS

**IX1M**

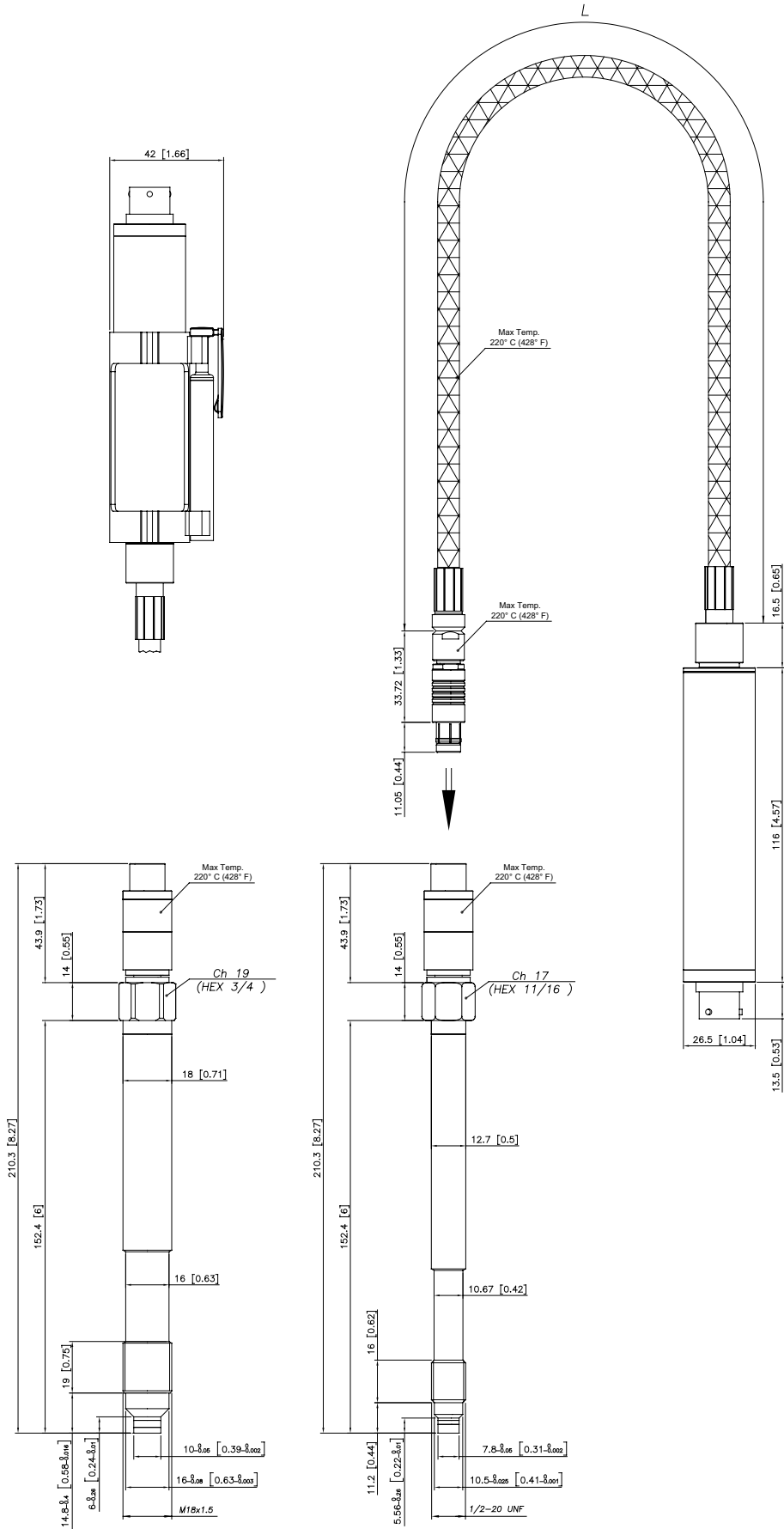

**NOTE :** dimensions refer to rigid stem length option "4" (153 mm – 6")

**WARNING :** For installation use a maximum tightening torque of 40 Nm (355 in-lb)

# MECHANICAL DIMENSIONS

**IX1S**

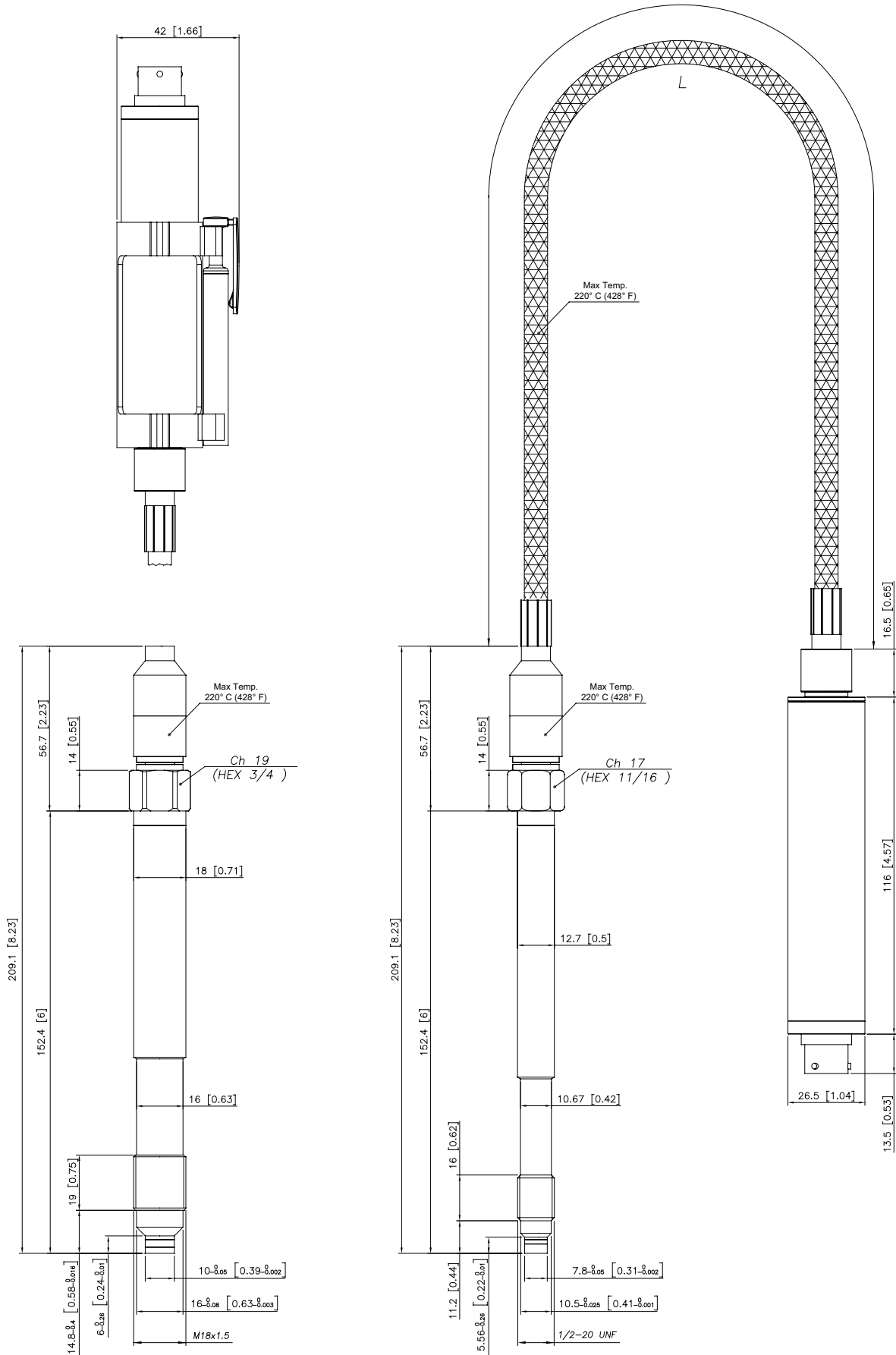

**NOTE :** dimensions refer to rigid stem length option “4” (153 mm – 6”)

**WARNING :** For installation use a maximum tightening torque of 40 Nm (355 in-lb)

# MECHANICAL DIMENSIONS

**IX2**

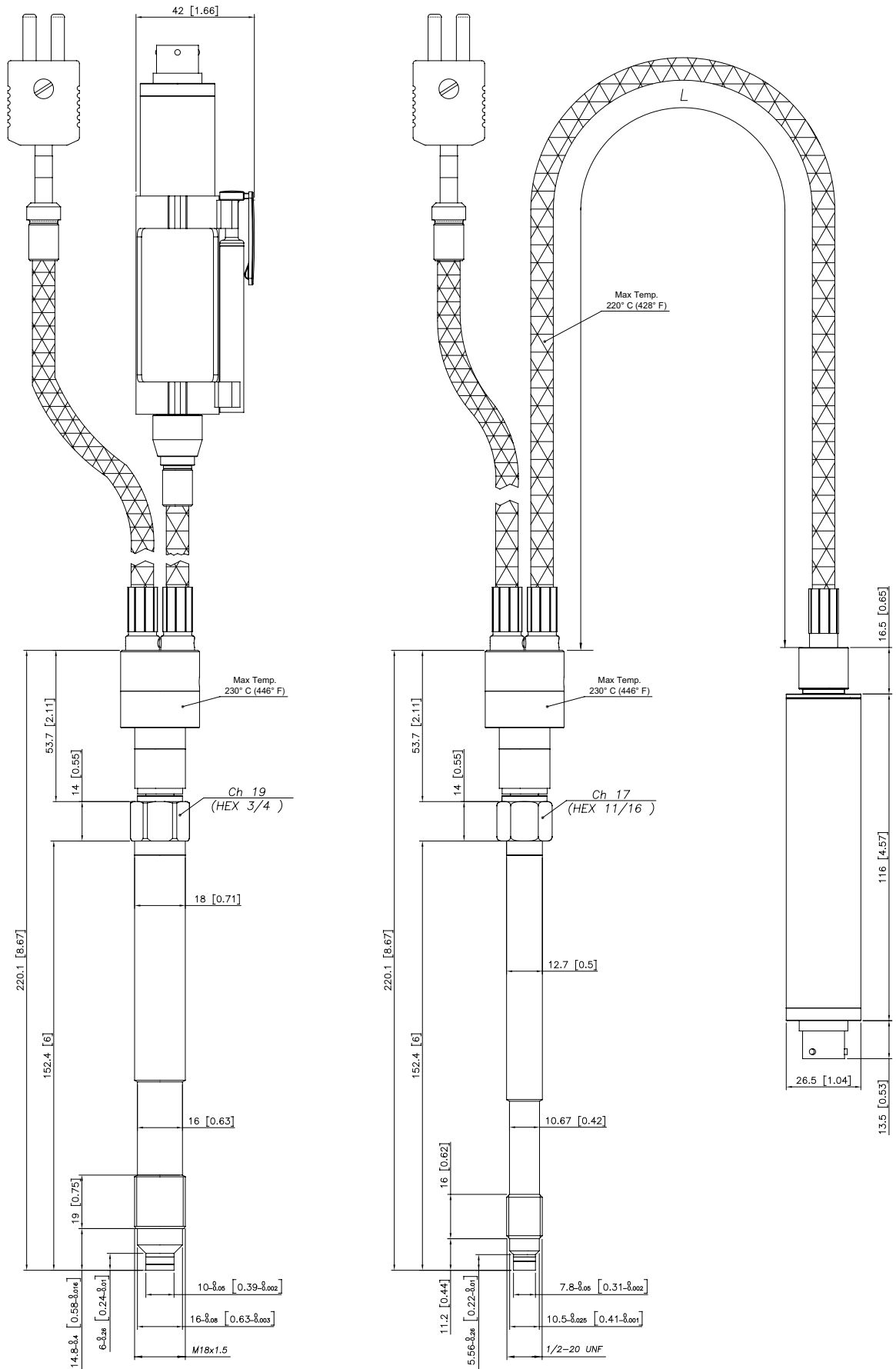

**NOTE :** dimensions refer to rigid stem length option "4" (153 mm – 6")

**WARNING :** For installation use a maximum tightening torque of 40 Nm (355 in-lb)

## ELECTRICAL CHARACTERISTICS AND TEMPERATURE CLASSES

MODEL	(*) LEVEL L2	(*) LEVEL L1	TEMPERATURE CLASSES	ROOM TEMPERATURE
IX0	> 165mm	> 125mm	T6/T85	-20...+60°C
			T5/T100	-20...+75°C
			T4/T135	-20...+85°C
IX1	> 665mm	> 625mm	T6/T85	-20...+60°C
			T5/T100	-20...+75°C
			T4/T135	-20...+85°C
IX2	> 665mm	> 625mm	T6/T85	-20...+60°C
			T5/T100	-20...+75°C
			T4/T135	-20...+85°C

(\*) with the level (L) in fig. 1, the table sets the minimum distance that the electrical circuit has to maintain from the block at high temperature.

 thermal isolating material with adequate thickness for the process temperature

 pressure transmitter housing block

 fluid at temperature (350°C)

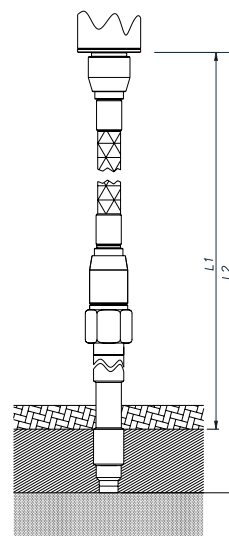

Fig. 1

## INTRINSIC SAFETY CHARACTERISTICS

### Main intrinsic safety characteristics

Transmitter designed and produced in compliance with Directive 94/9/CE ATEX and according to European standards: Protection:

II 1GD, Ex ia IIC T6, T5, T4 Ga, ambient temperature -20...+60°C / +75°C / +85°C;

Ex ia IIIC T85°C, T100°C, T135°C Da IP65, ambient temperature -20...+60°C / +75°C / +85°C

		II 1GD, EX ia IIC T6 Ga Ex ia IIIC T85°C Da IP65	II 1GD, EX ia IIC T5 Ga Ex ia IIIC T100°C Da IP65	II 1GD, EX ia IIC T4 Ga Ex ia IIIC T135°C Da IP65
Maximum voltage	Ui	30Vdc	30Vdc	30Vdc
Maximum current	Ii	100mA	100mA	100mA
Maximum power	Pi	0.75W	0.75W	0.75W
Maximum inductance (*)	Li	1.1 mH	1.1 mH	1.1 mH
Maximum capacity (*)	Ci	46nF	46nF	46nF
Ambient temperature		-20...+60°C	-20...+75°C	-20...+85°C

(\*) includes inductance levels and capacity of a cable: (typical L 1μH/m and typical C 100 pF/m) with maximum length 15mt.

## LOAD DIAGRAM

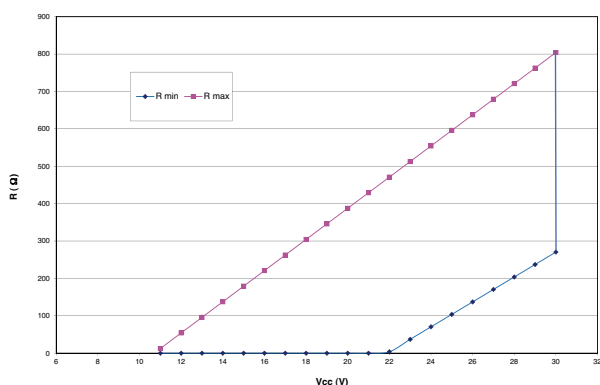

The diagram shows the optimum ratio between load and power supply for transmitters with 4...20mA output. For correct function, use a combination of load resistance and voltage that falls within the shaded area.

## AUTOZERO FUNCTION

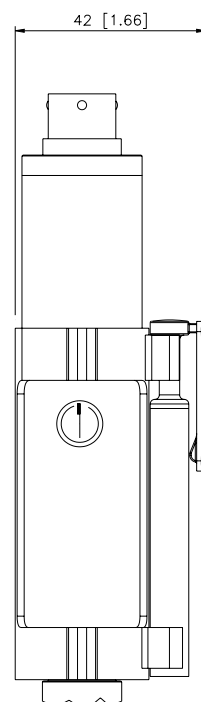

The Autozero function is activated through a magnetic contact (external magnet supplied with the sensor).

For the external Autozero version short-circuit the correct pin.

See the manual for a complete Autozero function explanation.

# ELECTRICAL CONNECTIONS

## CURRENT OUTPUT (4...20mA, 2-wires)

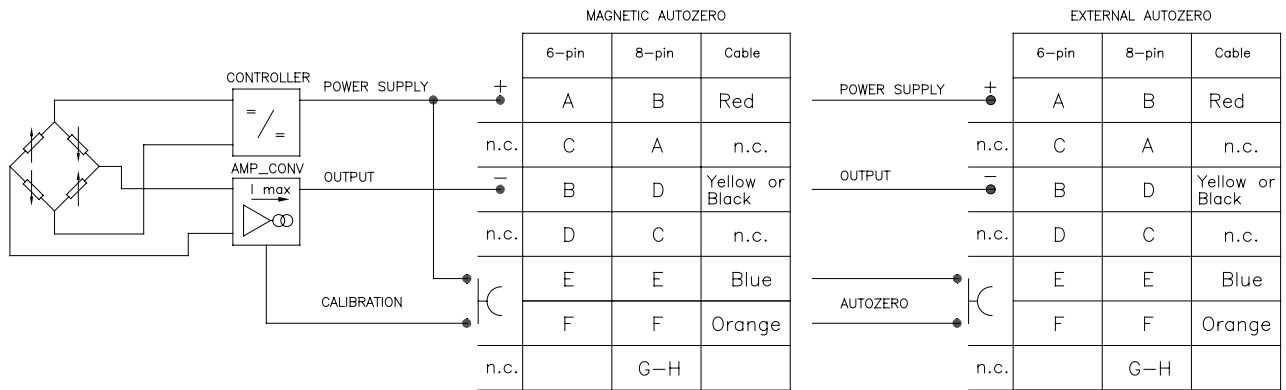

**8 pin connector  
PC02E-12-8P  
Bendix**

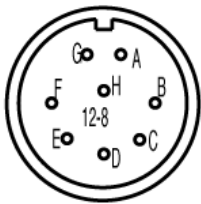

**6 pin connector  
VPT07RA10-6PT2  
(PT02A-10-6P)**

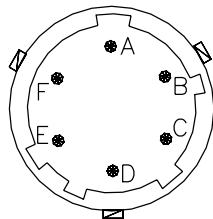

**4 pole cable**

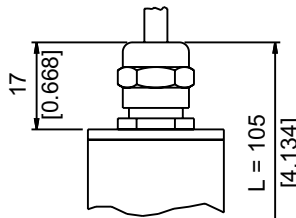

**4 pole cable**

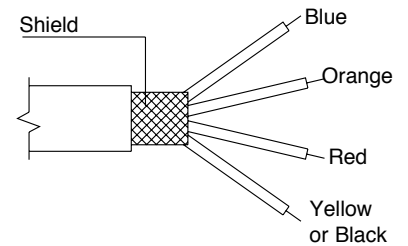

Shielded cable 4x0.25 - 2m.  
Protection IP65

## ACCESSORIES

### Connectors

6-pin female connector (IP65 protection degree)  
8-pin female connector

**CON300**  
**CON307**

### Extension cables

6-pin connector with 8m (25ft) cable  
6-pin connector with 15m (50ft) cable  
6-pin connector with 25m (75ft) cable  
6-pin connector with 30m (100ft) cable

**PCAV221**  
**PCAV104**  
**PCAV105**  
**PCAV106**

### Accessories

Mounting bracket  
Dummy plug for 1/2-20UNF  
Dummy plug for M18x1.5  
Drill kit for 1/2-20UNF  
Drill kit for M18x1.5  
Cleaning kit for 1/2-20UNF  
Cleaning kit for M18x1.5  
Fixing pen clip  
Autozero pen

**SF18**  
**SC12**  
**SC18**  
**KF12**  
**KF18**  
**CT12**  
**CT18**  
**PKIT 379**  
**PKIT 378**

### Cable color code

Conn.	Wire
A	Red
B	Black
C	White
D	Green
E	Blue
F	Orange

# ORDER CODE

I - - - - - 000

OUTPUT SIGNAL	
4...20mA	X

VERSION	
Rigid rod	0
Rigid + flexible stem	1
With thermocouple	2

MECHANICS	
Single fixed	A
Modular fixed	B *
Single	S
Modular	M *

\* Not available for IX0 and IX2 version

CONNECTOR	
6 pin	6
8 pin	8
Cable output	F

ACCURACY CLASS	
0.25% FSO	H
0.5% FSO	M

MEASUREMENT RANGE			
bar		psi	
20*	B02D	300	P03C
35	B35U	500	P05C
50	B05D	750	P75D
70	B07D	1000	P01M
100	B01C	1500	P15C
200	B02C	3000	P03M
350	B35D	5000	P05M
500	B05C	7500	P75C
700	B07C	10000	P10M
1000	B01M	15000	P15M

\* 10 bar (B01D) or 150psi (P15D) for version M18x1,5

000= Special executions of the standard version or of custom versions may be requested.

E	External Autozero
-	Magnetic Autozero

4	Ex ia T4 Ga/Ex ia T135°C Da
5	Ex ia T5 Ga/Ex ia T100°C Da
6	Ex ia T6 Ga/Ex ia T85°C Da

FLEXIBLE STEM LENGTH (L) (mm / inches)		
Standard (IX0)		
0	none	
Standard (IX1, IX2)		
D	457mm	18"
E	610mm	24"
F	760mm	30"
Available on request		
A	76mm	3" 1)
B	152mm	6" 1)
C	300mm	12" 1)
G	914mm	36"
H	1067mm	42"
I	1220mm	48"
J	1372mm	54"
K	1520mm	60"

RIGID STEM LENGTH (mm / inches)		
Standard (IX0, IX1, IX2)		
4	153mm	6"
5	318mm	12.5"
Available on request		
1	38mm	1.5" 1)
2	50mm	2" 1)
3	76mm	3" 1)
6	350mm	14"
7	400mm	16"
8	456mm	18"

1) in IX1 and IX2 versions, to use rigid stem and flexible with a total length  $\geq 665$ mm

THREADING	
Standard	
1	1/2 - 20 UNF
4	M18 x 1.5

## Example

### IX1-S-6-M-B07C-1-4-D-4

Melt pressure transducer without filling, 4-20mA output, 6-pin connector, 1/2-20 UNF threading, 700 bar pressure range, 0.5% accuracy, 153 mm (6") rigid stem, 457 mm (18") flexible stem; temperature class T4

Electrical installation requirements and Conformity certificate are available on our web site: [www.gefran.com](http://www.gefran.com)

GEFRAN reserves the right to make any kind of design or functional modification at any moment without prior notice

**GEFRAN spa**  
 via Sebina, 74  
 25050 PROVAGLIO D'ISEO (BS) - ITALIA  
 tel. 0309888.1 - fax. 0309839063  
 Internet: <http://www.gefran.com>  
[www.gefranonline.com](http://www.gefranonline.com)

# GEFRAN