



Main features

- Ranges: from 0...10 bar to 0...1000 bar (0...150psi to 0...15000psi)
- Accuracy: $\pm 0.15\%$ FSO typical
- Protection rating: IP65/IP67
- Wetted parts 17-4PH
- Temperature range $-40...+120^{\circ}\text{C}$

Series TPS transducers are based on the extensimetric measurement principle with strain gauges on metal base. An innovative mechanical structure makes the transducer completely insensitive to tightening during installation. This transducer is suitable for all those applications where in addition to ruggedness and reliability high accuracy is required.

TECHNICAL DATA

Accuracy (1)	$\pm 0.15\%$ FSO typical; $\pm 0.2\%$ FSO max $>200\text{bar}/3000\text{psi}$ $\pm 0.25\%$ FSO typical; $\pm 0.5\%$ FSO max $\leq 200\text{bar}/3000\text{psi}$
Resolution	Infinite
Overpressure (without degrading performance) (2)	See table
Pressure containment (Burst test) (3)	See table
Wetted parts	Fluid compatible with INOX 17-4PH Stainless Steel
Body materials	INOX AISI 304 Stainless Steel and Nylon 66GF35V0
Power supply	10 (max 15) Vdc/ac RMS
Common mode voltage	Typical 5V @ 10V supply
Output impedance	350 Ω (± 1)
Load impedance	$> 1000 \text{ K}\Omega$
Insulation resistance	$> 1000 \text{ M}\Omega$ @ 50Volt
Zero offset and span setting	$\pm 0.5\%$ FSO
Output voltage (sensitivity)	10...40bar / 150...500psi 1,5mV/V 50...60bar / 750...1000psi 2mV/V 100...1000bar / 1500...15000psi 3mV/V
Long term stability	$< 0.1\%$ FSO per year
Operating temperature range (process) (5)	$-40...+120^{\circ}\text{C}$ ($-40...+248^{\circ}\text{F}$)
Compensated temperature range (4)	$-20...+85^{\circ}\text{C}$ ($-4...+185^{\circ}\text{F}$)
Storage temperature range	$-40...+125^{\circ}\text{C}$ ($-40...+257^{\circ}\text{F}$)
Temperature effects over compensated range (zero-span)	$\pm 0.01\%$ FSO/ $^{\circ}\text{C}$ typical ($\pm 0.02\%$ FSO/ $^{\circ}\text{C}$ max.)
Mounting position effects	Negligible
Humidity	Up to 100% RH non condensing
Weight	130 gr. nominal
Mechanical shock	100 g / 11 msec. according to IEC 60068-2-27
Vibrations	20 g max @ 10-2000Hz according to IEC 60068-2-6
Ingress protection	IP65/IP66/IP67

FSO = Full Scale Output

1 Includes combined effects of Non-Linearity BFSL (Best Fit Straight Line), Hysteresis and Repeatability

2 tested for more than 1000 strokes with single duration $< 2\text{msec}$.

3 tested for more than 100 strokes with single duration $< 2\text{msec}$.

4 temperature outside compensated range may cause zero signal drift

5 ambient and/or electronics part temperature must not exceed 105°C

MEASUR. RANGE (Bar)	10	16	20	25	30	35	40	50	60	100	160	200	250	350	400	500	600	700	1000
Overpressure	20	32	40	50	60	70	80	100	120	200	320	400	500	700	800	1000	1200	1400	2000
Burst test	40	64	80	100	120	140	160	200	240	400	640	800	1000	1400	1600	2000	2400	2500	2500

INSTALLATION DRAWINGS

Dimensions: mm [inches]

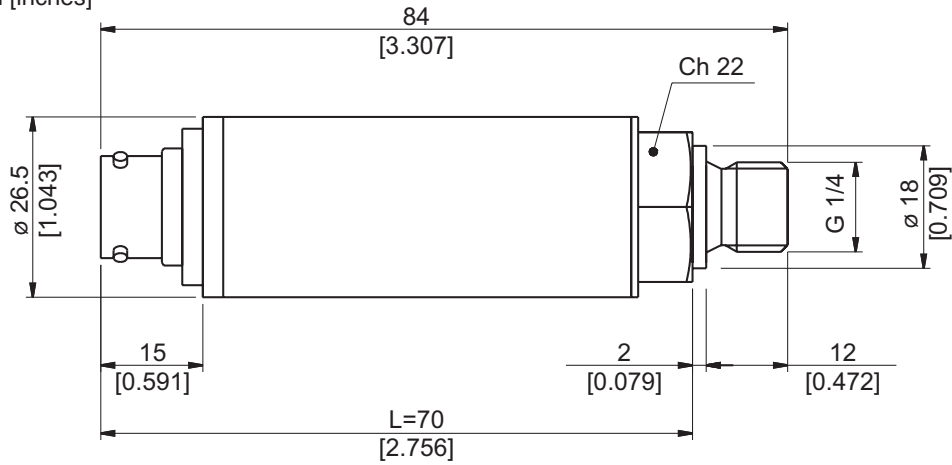

PRESSURE CONNECTION

(1) G 1/4 MALE (DIN 3852-A)

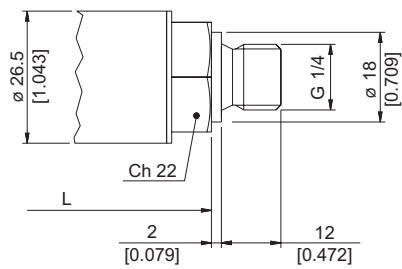

(2) SAE 04 AS4395 - E

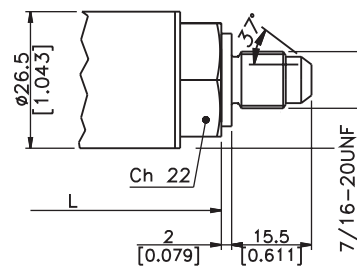

(3) G 1/2 A (DIN 16288)

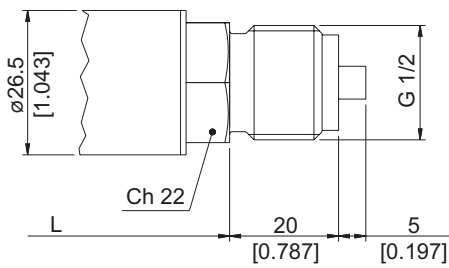

(4) G 1/4 FEMALE

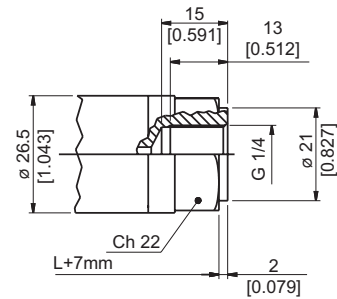

ELECTRICAL CONNECTION

P - 7 pole connector

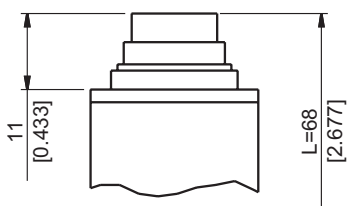

V - 6 pole connector

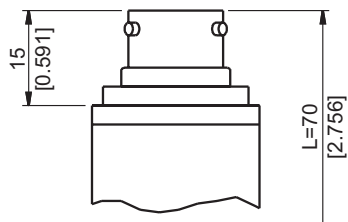

F - 6 pole cable

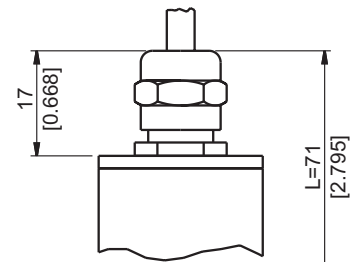

Z - 4 pole connector
M12 x 1

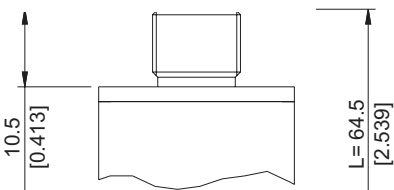

E - 4 pole connector
solenoid

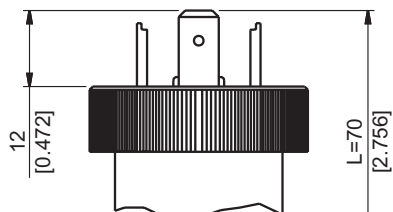

M - 4 pole connector
microsolenoid

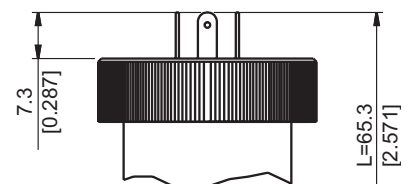

ELECTRICAL CONNECTION - Connectors

P - 7-pole connector

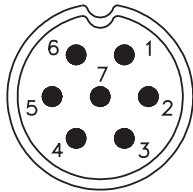

Male connector 09-127-09-07
Protection IP67

V - 6-pole connector

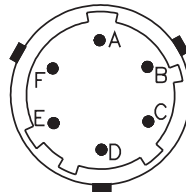

Male connector VPT02A10-6PT2
Protection IP66

Z - 4 pole M12 x 1 male connector

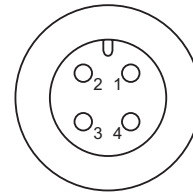

Male connector 4 pole series 713
Protection IP67

E - 4 pole solenoid connector

M - 4 pole microsolenoid connector

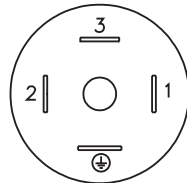

Solenoid DIN 43650A - ISO4400
Microsolenoid DIN 43650C - ISO4400

Protection IP65
Protection IP65

F - 6 pole cable

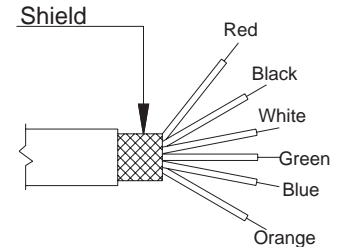

F - Shielded cable 6 x 0.25 - 1m.

ELECTRICAL CONNECTION - connection diagrams

mV/V output

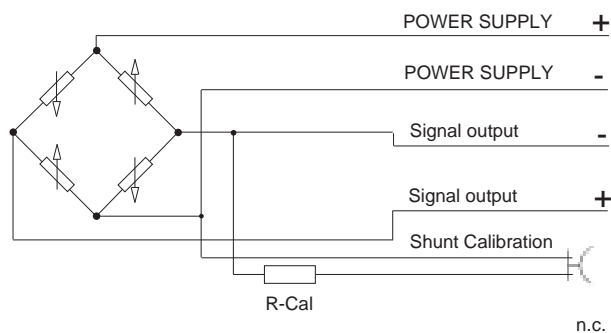

Code V	Code P	Code F	Code E/M	Code Z
C	1	White	3	1
D	2	Green		2
B	4	Black or Yellow	2	4
A	3	Red	1	3
E - F	5 - 6	Blue/ Orange or Violet	Not available	Not available
	7			

Cable shield connected to transducer body

ACCESSORIES ON REQUEST

Connectors

Connection E

3 pole connector + ground DIN43650A ISO4400
Prot. IP65

CON 006

Connection M

3 pole connector + ground DIN43650C ISO4400
Prot. IP65

CON 008

Connection Z

4 pole female cable connector M12x1
Prot. IP67

CON 293

Connection Z

4 pole female cable connector, 90° M12x1
Prot. IP67

CON 050

Connection P

7 pole female cable connector,
Prot. IP67

CON 321

Connection P

7 pole female cable connector,
Prot. IP40

CON 320

Connection P

7 pole female cable connector 90°,
Prot. IP40

CON 322

Connection V

6 pole female cable connector,
Prot. IP66

CON 300

O-ring

O-ring seal for G1/4 gas male pressure connector (1)

RON 300

EXTENSION CABLES

6 pole female connector (CON 300) + 2 m (6.5 ft) of cable (6x0.25)
6 pole female connector (CON 300) + 4 m (13 ft) of cable (6x0.25)
6 pole female connector (CON 300) + 6 m (20 ft) of cable (6x0.25)
6 pole female connector (CON 300) + 8 m (25 ft) of cable (6x0.25)
6 pole female connector (CON 300) + 10 m (33 ft) of cable (6x0.25)
6 pole female connector (CON 300) + 15 m (50 ft) of cable (6x0.25)
6 pole female connector (CON 300) + 20 m (66 ft) of cable (6x0.25)
6 pole female connector (CON 300) + 25 m (82 ft) of cable (6x0.25)
6 pole female connector (CON 300) + 30 m (100 ft) of cable (6x0.25)
Other lengths

C02W

C04W

C06W

C08W

C10W

C15W

C20W

C25W

C30W

on request

Cable color code	
Pin	Wire
A	Red
B	Black
C	White
D	Green
E	Blue
F	Orange

ORDERING INFORMATION

Pressure transducer

TPS

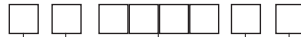

PRESSURE CONNECTION	
Standard	
G 1/4 gas male	1
On request	
7/16-20 UNF-2A male (SAE 4 for AS4395-E)	2
G 1/2A (DIN 16288)	3
G 1/4 gas female	4
1/8-27 NPT female	5
1/4-18 NPT female	6
1/4-18 NPT male	7
M14 x 1.5 male	8
1/8-27 NPT male	9
G 1/4 male (DIN 3852-E)	E
M12 x 1.5 male	R
7/16-20 UNF-2A male (SAE 4 for J1926-2) (*)	K
7/16-20 UNF-2A female (SAE 4)	F

(*) Max. working pressure:
630 bar (9137 psi)

ELECTRICAL CONNECTION	
4-pole connector solenoid	E *
shielded cable	F
4-pole connector	Z *
4-pole connector microsolenoid	M *
7 pole connector	P
6 pole connector	V

(*) Calibration signal not available



GOST-R CERTIFICATION

TPS pressure transducer is available with GOST-R certification. The request of this version must be specified on the order.

Mechanical and/or electrical characteristics differing from standard may be arranged on request.

ACCURACY

T	±0.15% FSO typical >200bar/3000psi ±0.25% FSO typical ≤200bar/3000psi
----------	--

MEASUREMENT RANGE

	bar		psi
B01D	0..10	P15D	0..150
B16U	0..16	P25D	0..250
B02D	0..20	P03C	0..300
B25U	0..25		
B03D	0..30		
B35U	0..35	P05C	0..500
B04D	0..40		
B05D	0..50	P75D	0..750
B06D	0..60	P01M	0..1000
B01C	0..100	P15C	0..1500
B16D	0..160	P02M	0..2000
B02C	0..200	P25C	0..2500
B25D	0..250	P03M	0..3000
B35D	0..350	P04M	0..4000
B04C	0..400	P05M	0..5000
B05C	0..500	P75C	0..7500
B06C	0..600		
B07C	0..700	P10M	0..10000
B01M	0..1000	P15M	0..15000

CALIBRATION STANDARDS

Instruments manufactured by Gefran are calibrated against precision pressure calibration equipment which is traceable to International Standards.

Ex.: **TPS - 4 - V - B07C - T**

Pressure transducer TPS with G 1/4 female process connection, 6 pole connector, 0...700 bar measurement range, ± 0.15% FSO accuracy.

GEFRAN spa reserves the right to make any kind of design or functional modification at any moment without prior notice

GEFRAN spa
via Sebina, 74
25050 PROVAGLIO D'ISEO (BS) - ITALIA
tel. 0309888.1 - fax. 0309839063
Internet: <http://www.gefran.com>

GEFRAN

DTS_TPS_0408_ENG